

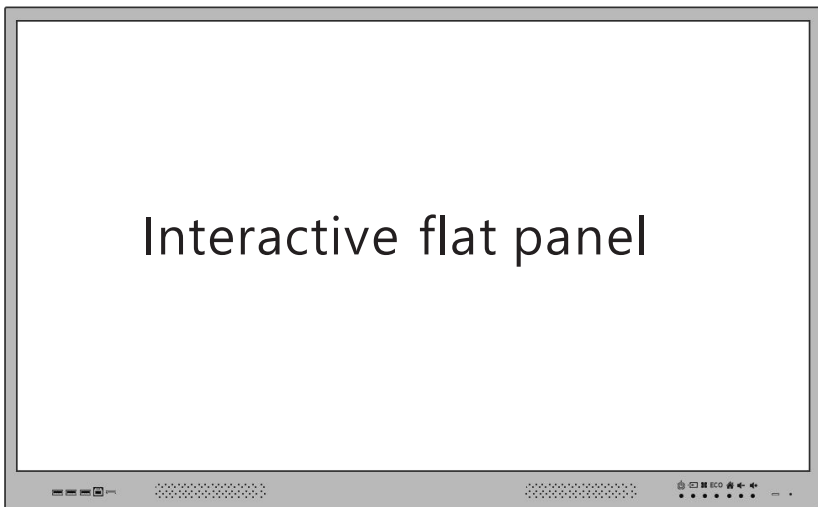









User manual



Content

1. Accessories	3
2. Installation	4
3. Powering the display	6
4. OPS module	6
5. PC connection	7
6. Connections	8
7. Front Ports	10
8. Control keys	10
9. Remote Control	11
10. Android System	12
Home Screen	12
Apps	15
Settings	20
12. Certificates	22

Accessories

Picture	Product name	Quantity (pcs)
	Remote control	1
	Power cord	1
	Pointer	1
	HDMI cable	1
	TOUCH cable	1
	Wifi dongle	4
	Wall mounting Brackets (set)	1
	Screws (set)	1
	whiteboard pen(without ink)	2

Installation

● Bearing

1. Interactive flat panel can be installed on the wall or mobile stand.
2. Mobile stand can purchase from interactive flat panel manufacturer. If purchase by yourself, make sure it could bear at least 4 times weight of the panel and make it stable.
3. Please make sure the building bearing capacity at least 4 times of panel weight when you chose wall mount bracket.
4. If install on wall or a roof of building, it must be solid brick, concrete or other surface equivalent strength. If the surface is loose material (such as old-style house brick, wood, solid brick, etc.), or metal, non-metallic structure, or surface decoration layer is thick, its strength is obviously insufficient, it should take appropriate reinforcement and support measures to prevent potential safety hazards.

● Heat dissipation

Requirement	Safety distance between panel and mounting surface (mm)			
power	Left and right	top	bottom	back
≥ 100W	200	200	200	100
 Notice	*When wall-mounted, the safety depth of the bolt should be more than 10mm; *Make sure do not block the vents .			

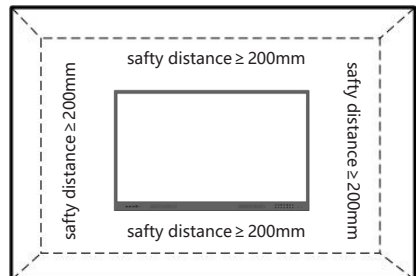

● Installation

(1) Wall mount dimension:

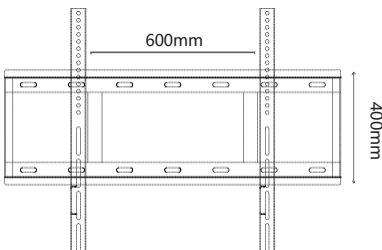

65"

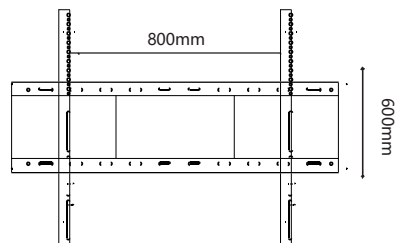

75" / 86"

(2) Mounting Accessories :

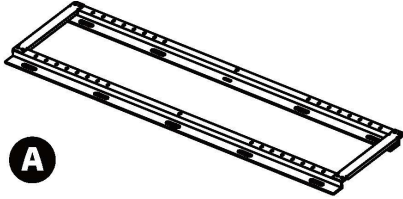

A

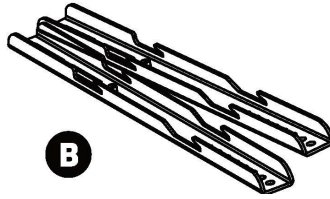

B

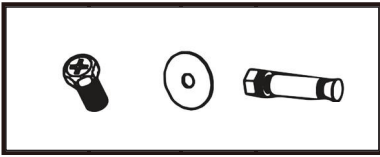

C

A	Wall mount frame	1pcs
B	Wall mount bracket	2pcs
C	M8 Fixing screws	4pcs
	Anchor screws	8pcs

(3) Installation steps :

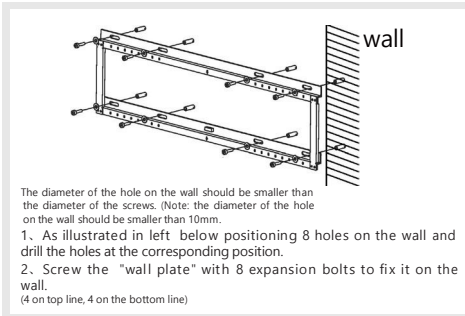

①

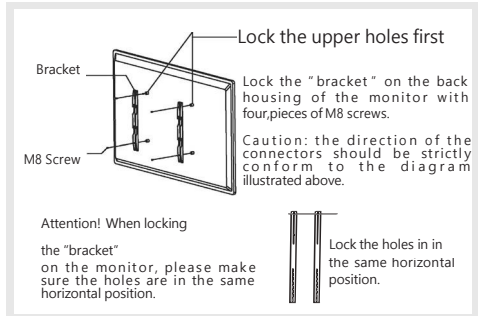

②

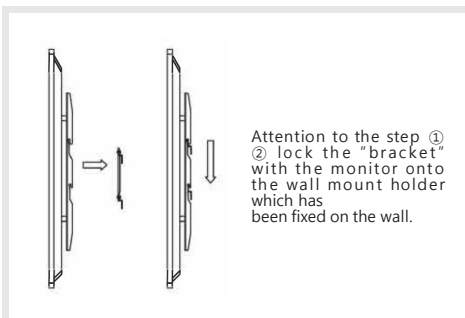

③

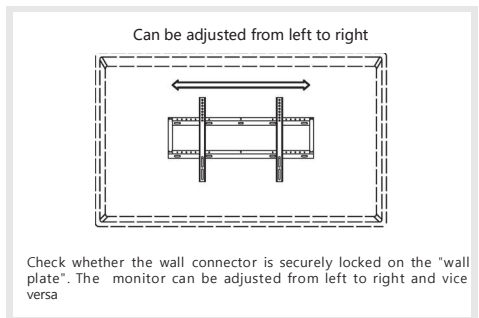

④

 Warning

-
1. Please read this instruction before installation and follow below steps strictly.
 2. It should be installed by at least two professional people.
 3. When setting the panel down to install the wall mount, place it face down on a flat and stable surface covered by a protective sheet or cloth and a table cushion. DO NOT place the display on an uncovered surface.
 4. Installation surface must be strong materials.
-

Powering the display

•Power on

1. Press the Power button on the remote controller or panel to turn on , the power indicator light changes from red to blue
2. Dual system will power on once you start display.

•Power off







1. Press the Power button on display
2. Dual system will power off after you press power button
3. Display will get standby mode after power off

OPS module

- Connect the OPS module same as image. Connection complete, just power on the display.



PC connection

<p>1.HDMI Connect HDMI to broadcast video and audio</p>	
<p>2.VGA Connect VGA to broadcast video</p>	
<p>3. Audio Cable Connect 3.5mm audio cable to broadcast audio</p>	
<p>4. DP Connect the DP to broadcast video and audio</p>	
<p>5. Type-C Connect Type-C to broadcast video, audio or charging, read external storage device</p>	
<p>6. The USB Cable for Touch Connect the USB cable from PC USB port to the display Touch USB port.</p>	

Connections

LTS982E





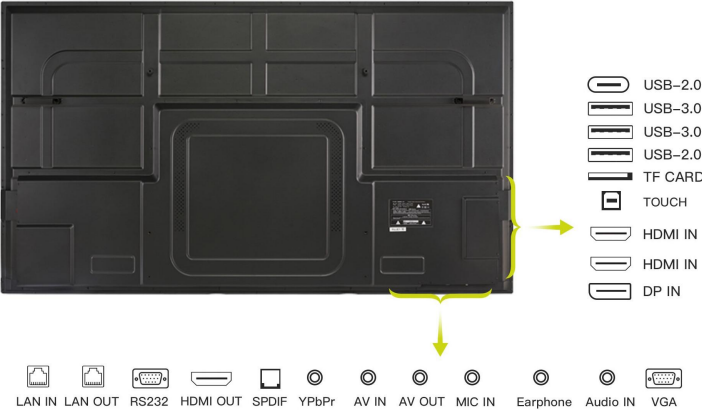



LTS982S









RS232	Connects to a computers or servers for control commands.
LAN IN/OUT	Used for data transmission, the most common application is the network card interface
VGA IN	Connects to a computer to broadcast video.
VGA Audio IN	Connects to a computer to broadcast audio.
MIC IN	Connects to a Microphone
EARPHONE	Connects to earphone
SPDIF	Audio optical fiber interface, this must be used with the corresponding peripherals, is to output the sound signal to the power amplifier through the optical fiber line
Speaker	Connect to external speaker
USB 2.0/3.0	Connects to a USB flash drive to view media files or to a mouse/keyboard.
HDMI IN	Connects to Blu-Ray/DVD players, set-top boxes, digital media players, computers, or other video sources to broadcast video and audio
TOUCH USB	Connects to a computer to allow the touchscreen to control the computer's interface.
Android USB	Connects to a USB flash drive to view media files or to a mouse/keyboard.
USB C	Connects to mobile device or laptop for charging, data transmission, display output and other functions.
TF CARD	Users can use a TF card for extending the panels storage.
HDMI OUT	HDMI signal output, export HDMI signal to other devices for playback

Front Ports

Picture	Function Instruction
	Connects to a USB flash drive to view media files or to a mouse/keyboard
	Connects to a USB flash drive to view media files or to a mouse/keyboard
	Connects to a USB flash drive to view media files or to a mouse/keyboard
	Connects to a computer to allow the touchscreen to control the computer's interface
	Connects to Blu-Ray/DVD players, set-top boxes, digital media players, computers, or other video sources to broadcast video and audio.
	Full functions of USB Type-C

Control keys

Picture	Functions
	Indicator light, Red is standby, blue is power on
	Power
	Input resource
ECO	Energy saving
	Home
	Menu
	Volume up
	Volume down

Remote Control



Notice:

- Change the batteries if remote controller can not work properly.
- Please do not mix new batteries with old one or different types batteries.
- Please change the batteries when power is weak, electrolyte will happen when weak power, and it will damage remote controller.
- Please take off the batteries to avoid electrolyte leakage if long time no use.
- Please unplug the power for long time no use the display.

Functions description	
	Power :Turns the display on or off
	Mute: Disables the display's audio.
0-9: Numeric Keypad Numeric input buttons	
Alt+tab	Performs the same action as the Alt+Tab key combination on a PC keyboard.
Alt+F4	Performs the same action as the Alt+F4 key combination on a PC keyboard.
	Windows Menu:Performs the same action as the Windows key on a PC keyboard
	Right click in Windows
	Navigation Buttons:Navigates between various applications and menus shown on screen.
	Start the whiteboard software in Windows
Esc/Exit	Exit from current operation or menu
Pgup/PgDn	Page up/down in Windows
Vol+/vol-	Adjusts the display's audio level
CH+/CH-	TV channel adjustment
Input	Selection input-signal source
Menu	Opens the input source menu
Enter	Enter
Reset	Reset the display
	Open/close the backlight
PC	Switch to OPS module
VGA	Switch to VGA input
HDMI	Switch to HDMI input
MEDIA	Switch to MEDIA
Display	Display the program
P.Mode	Picture mode
Sleep	Sleeping
S.Mode	Sound mode
F1	Help
F2	Rename
F3	Search
F4	IE browser address list
F5	Refresh
F6	Resource manager
F7	Windows media player mute
F8	Windows media player volume+/-
F9	Child lock
F10	Office files saving
F11	IE browser full screen
F12	File list

Android System

● Home screen

Main interface includes: Recent Apps, Whiteboard, File, OPS, customize common App list bar.

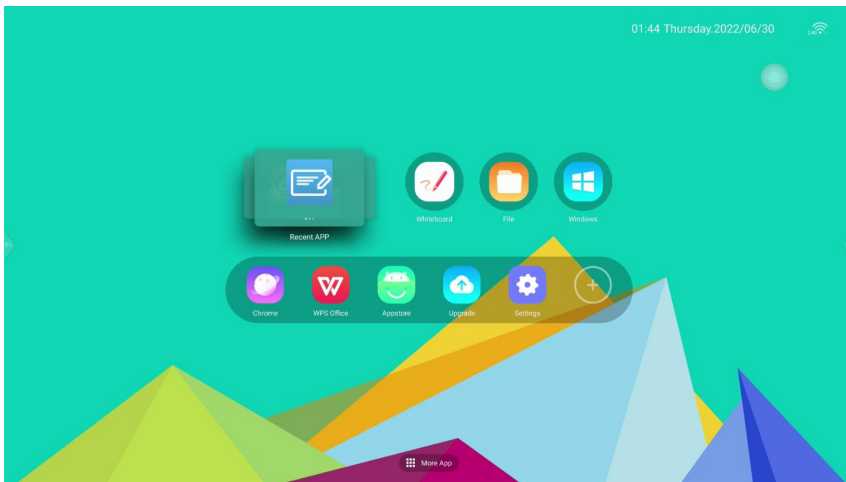

More functions can be found as below show you:

- ① Control Center
- ② Internet
- ③ Time
- ④ Float icon
- ⑤ Side bar (Right&Left)
- ⑥ Input resource
- ⑦ Main function icon
- ⑧ More App



① Control Center :

- Quick start for WiFi, Cut, Record screen, Pen, calendar, Freeze, Timer, Calculator.
- Theme of background color can be changed: purple, blue, green. Also can customize with OEM background.
- Different scenes: classroom, meeting room, exhibition hall, living room. Different scene, you can customize different gesture from top, bottom, left, and right positions to start different apps.
- Bottom toolbar: Power, OPS, Setting, Input source, .

② Internet :

- Display network connection like Ethernet, WiFi 2.4G/5G , No network
- Display Bluetooth connection, not display when no Bluetooth.

- ③ **Time** : Time and date will display when you set the correct time zone and connect internet.

④ Float icon(right&left) :



- Float icon can be on/off by users in setting menu.
- It will show once you start it.
- Fixed 9 functions can not set by users.
- Click  button to add *the* apps you want

⑤ Side bar

When the sidebar is expanded, if there is no operation, it will be hidden automatically after 3s.



1. Back: return to the upper menu
2. Home: return to the home screen
3. Task managements: check the background running apps, Click the clean button on right corner to close all the running apps
4. Input: check the input source list
5. Pen Annotation: start annotation function, works in any input source, users can insert pictures, share with QR code; save; Create and delete pages; change pen color.

⑥ Input source :



Click  button at the bottom of Center to get input source list, click the one you need.



- Default HDMI1, HDMI2, PreHDMI, OPS, DP, VGA and Type-C, AV, YPBPR input sources
- Add a name for the input sources :
 - Long Click to input the name from keyboard
 - Long click to add a customized name with keyboard.

⑦ Main function icon :

- Recent App: Click to check the Apps used recently.
- Default Apps: Whiteboard, File, Windows (OPS)
- Customize Apps list: Chrome, WPS, App Store, OTA update, Settings, Custom.

⑧ More App: Click here to get more App functions

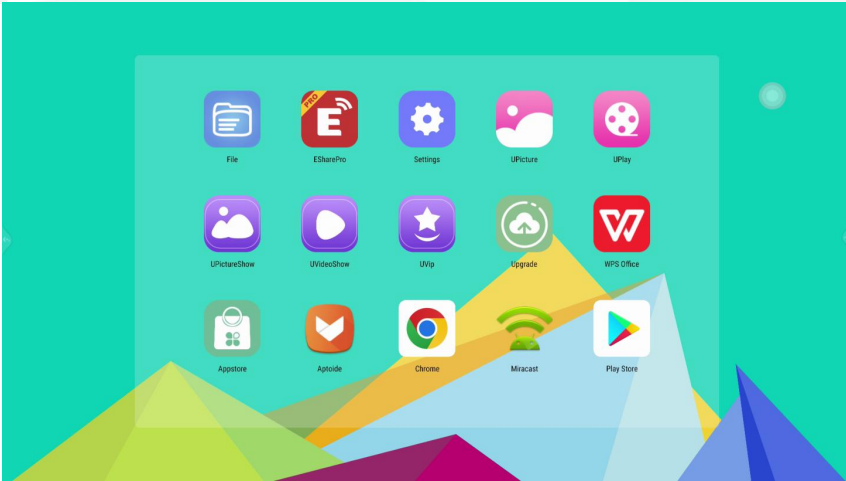

◎ Apps:

① **Umind(Whiteboard)**  :

Umind whiteboard allow users record their ideas freely.

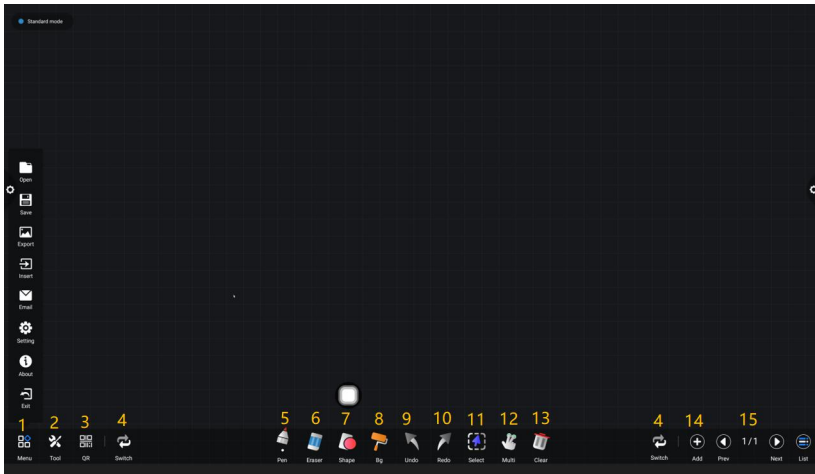

NO.	Name	Description
1	Menu	Open, Save, Export, Insert, Email, Setting, About, Exit
2	Tool	Exit Ruler, Compass
3	QR code	Share (email and QR code)
4	Switch	Switch the Menu, Tool and QR from to other side
5	Pen	Different Pens and color
6	Eraser	Different erasers
7	Shape	Different Shapes, such as line, arrows, triangle, quadrangle and so on

NO.	Name	Description
8	Bg	Background, could change to different backgrounds on the whiteboard
9-10	Undo/Redo	Undo/Redo the action
11	Select	Select the objects in the whiteboard
12	Multi	Switch Multi or Single touch
13	Clear	Page clean
14	Add	Add more pages
15	Pages	Preview and deletion pages

② File 

•File manager UFile Help users browse files stored in Android system memory or external storage devices connected to the display , At the same time, the file manager supports opening cloud resources ; Support LAN operation ; Open teaching application scenario ; Open desktop files, etc.

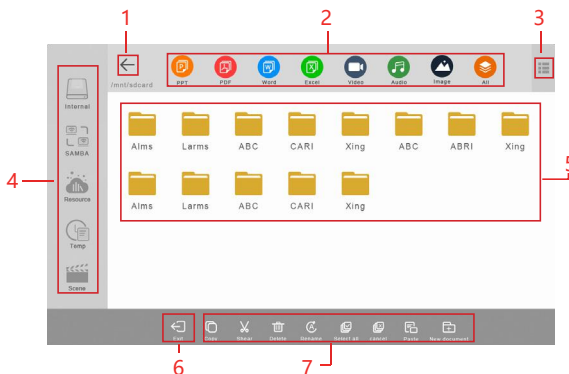

No.	Function	Description
1	Back	Return upper folder path
2	File Format	word、 Excel、 PPT、 PDF、 Video、 audio、 picture
3	Display method	Display by list or icon
4	Storage device	Click to select built-in or external storage and cloud files and files in the local area network for browsing
5	Main display area	Display the files in the storage device, click to open the file
6	Exit	Exit File Management
7	Operating	Including copy, cut, delete, rename, select all, paste, etc.

③ EShare

- Click EShare to launch it. Smart devices like mobile phone, tablet or laptop can connect to screen wireless, screen also share with smart device too.
- Make sure the screen and smart devices in the same WiFi before you launch it.
- License will needed when you use EShare.

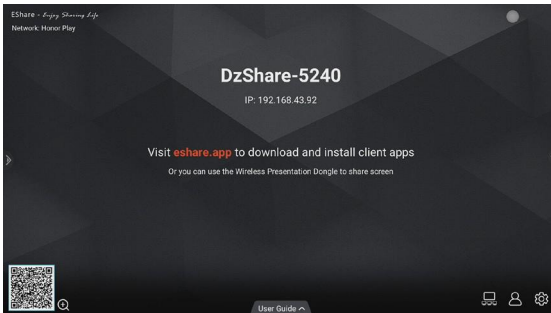

How to use :

- 1.Please connect the smart device and display in the same WiFi.
- 2.Scan the QR code to download and install EShare app to mobile device.
- 3.Run EShare app in mobile device and click EShare ID you want to connect.
- 4.The mobile device is successfully connected to the display .
- 5.After connect :
 - 2 screen transfer mode :display to mobile device, mobile device to display.
 - Operate the display by using the mobile device as a remote control.
 - Annotate and edit to the display on mobile devices.
 - EShare ID , split screen settings and other options can be set by touch the display right bottom corner.

④ WPS

- Office and PDF files running by WPS, including PDF, Word, PowerPoint and Excel.
- Edit files with WPS :
 - 1.Open folder on the left panel to preview and open files in display memory, storage device or cloud storage.
 - 2.Click function menu on the top to access various functions of different file format.

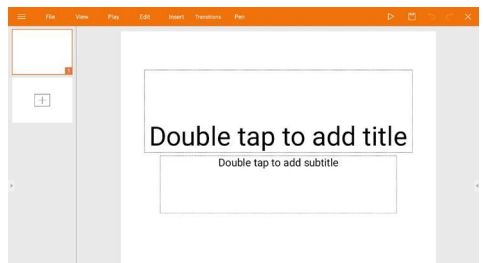
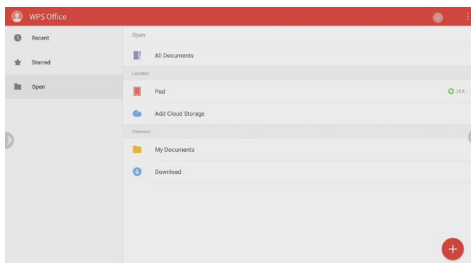



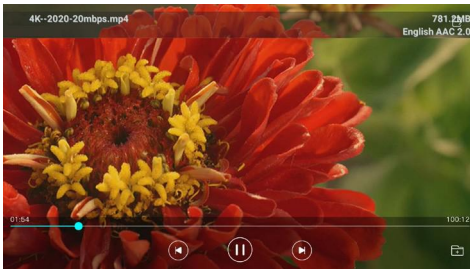

⑤ APP Store  :

- App store include Recommended Boutique and 3rd part Recommended app. The boutique recommend apps all developed by manufacturer, 3rd party apps are some popular free apps.
- Some highly recommended software will show on the panel.
- Access to App store only available when MAC address activated by manufacturer.



⑥ UPlay  :

- Video player developed by manufacturer.
- Support video format (codec) up to 4K resolution :

Icon	Function
	Play/pause
	Previous video
	Next video
	Open folder to select video file
	Exit the current video player

- **avi**
MPEG-1 | MPEG-2 MP@HL | MPEG-4 SP@L0-3 | ASP@L0-5 | H.264 | MP | HP@Level 4.1 | H263 | VP6 | MJPEG
- **mov**
MPEG-4 SP@L0-3 | ASP@L0-5 | MJPEG | H.264 MP | HP@Level 4.1 | H265
- **mp4**
MPEG-4 SP@L0-3 | ASP@L0-5 | H.264 MP | HP@Level 4.1 | H265

⑦ UVip  :

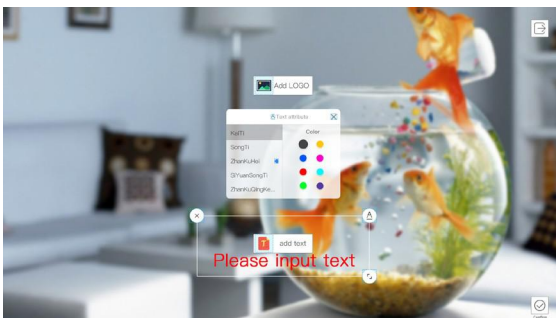

- Start UVIP to VIP signature app. Users can add logo picture for signing, change pen property such as color, font settings, etc.
- Play function is available after user set the logo and pen.
- Signed screen can be saved as JPG format to local storage.
- Signature interface can be shared to mobile devices with QR code.

⑧ Freeze  :

- Freeze can freeze current interface, and some special functions.
- Function as below :



- Freeze : Freeze the page under any interface.
- Countdown: It can be used for exams, important ongoing events, and can be set to any time within 1 hour.
- Please be quiet: used in scenes that require quietness, such as exams, major speeches, etc.
- Ten minutes of rest: used for courseware rest, inter-field rest, etc.
- Homework: teachers can leave homework here.
- Customize: You can customize the content of the frozen screen. After writing, you can enter the frozen screen mode.

Freeze screen mode for homework:

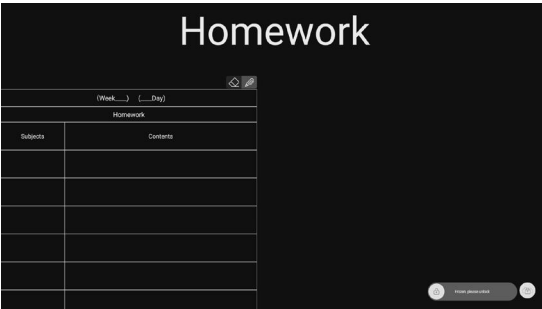

Useful App Ucut

- works in both Android or other input resource.

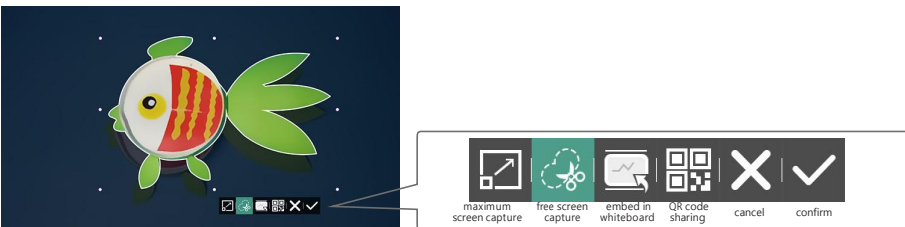

● Settings:

Settings divided to 3 parts: General setting, Network&Connected device, and Device&System. Click the Settings in Center to enter the Settings interface.

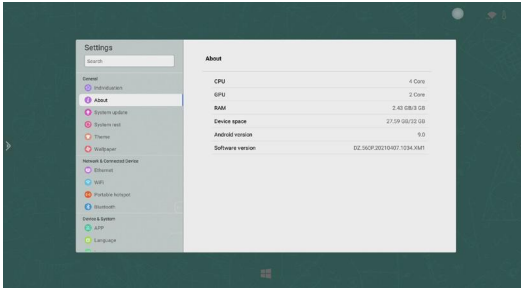

Options	Description
General:	
Individuation	Device name and Mac address
About	Configuration, firmware version and company information
System update	Local upgrade and online upgrade
System reset	Factory data reset

Network & Connected device:	
Ethernet	IP and DNS setting
WiFi	Wi-Fi setting
Portable Hotspot	Hotspot to generate connecting with other devices
Bluetooth	Bluetooth connect and setting
Device&System :	
App	All apps installed in Android, uninstall the apps installed by users
Language	Language setting
Input	Keyboard input setting
Date and time	date, time and formats setting
Time zone	Timezone setting
Picture	Picture display mode
Security	Child lock setting
Timing power& sleep	Shutdown time and sleep setting

① MAC address :

•The ID of the display, some setting can be changed and OTA is available by manufacturer.

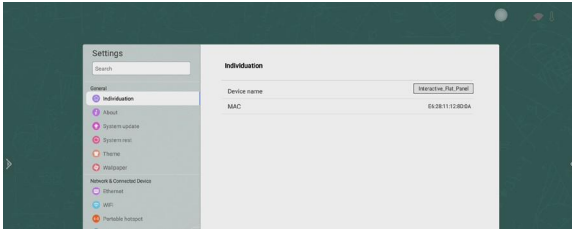

② OTA upgrade :

•2 ways to update the firmware: online upgrade and local upgrade.

Click "online upgrade", it will show the version installed and if you need upgrade. You can decide upgrade of not if it remind you new firmware there.

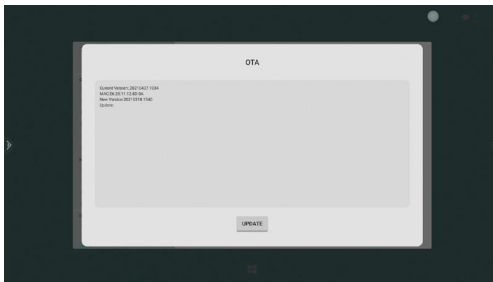
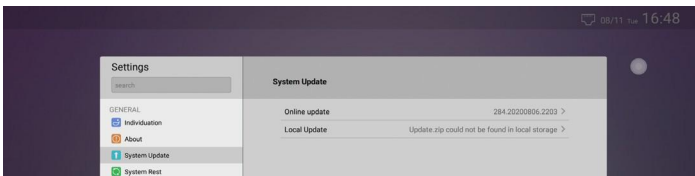

③ WiFi :

•WiFi should connect with WiFi antenna in the accessories box, WiFi list as below:

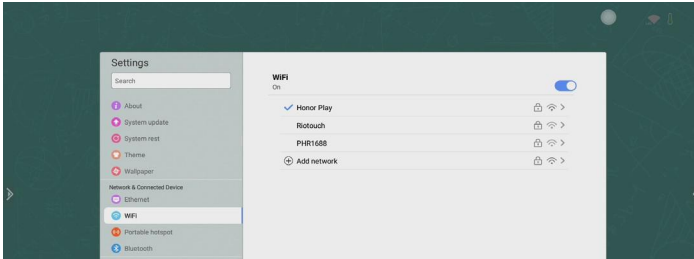

•If WiFi list does not appear, click any another options of setting (such as Ethernet), and back to WiFi, the list will appear.

•Password will needed when first time connect, it will connect automatically later.

④ Security> Child Lock :

•The child lock used to unlock the frozen screen.

Child lock setting:

- 1.Slide the sliding button in the figure as below to turn on the child lock
- 2.click "Password Settings" to set new password(default one is 2580) and save.

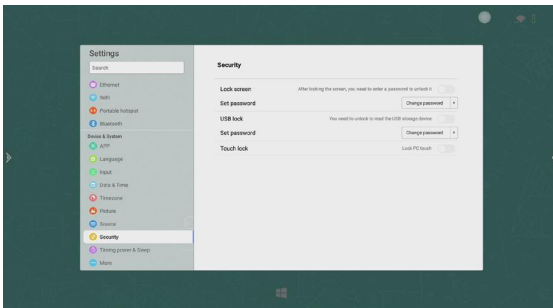

CERTIFIED

